



**Federal Aviation  
Administration**

# On Landings Part III





## Introduction

The first two pamphlets in this three-part series discuss undershoots, hard landings, bounced landings, go-arounds, and other landing issues. This document focuses on other landing challenges, including avoidance of gear-up landings, handling landing gear emergencies, landing on wet or ice-contaminated runways, and landing at night.

## Gear-Up Landings

There are all sorts of stories about gear-up landings.

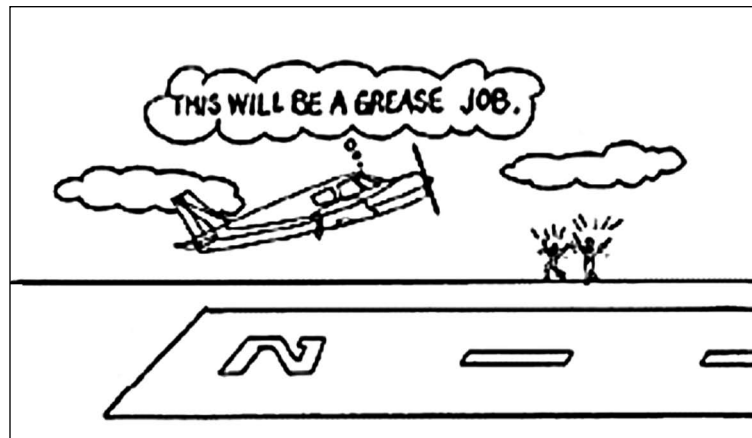

Horns, buzzers, and bells were invented to warn of gear-up approaches, but pilots sometimes ignored these horns, mistook them for stall warnings, or got so distracted that they continued to forget the gear until that sinking feeling struck them.

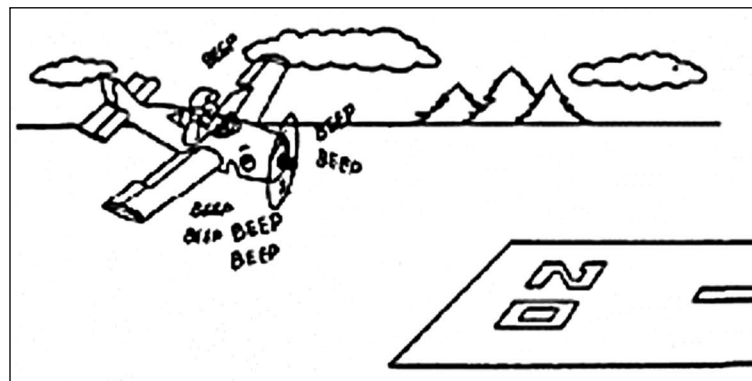

Other pilots thought they heard the outer marker horn blaring all the way down to a gear-less touchdown.

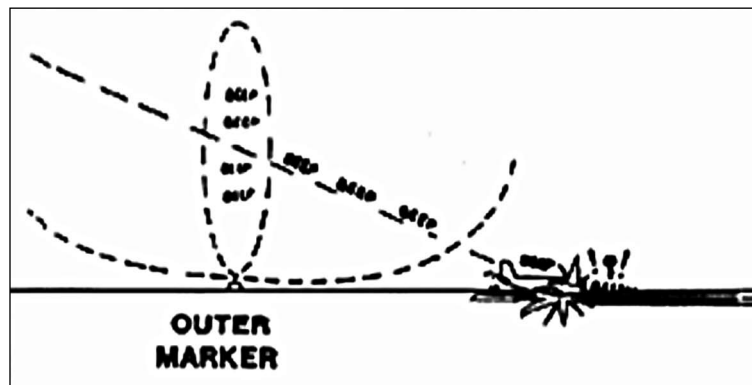

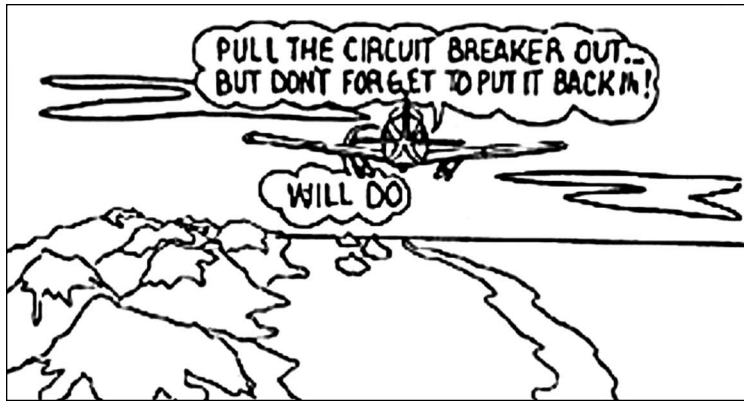

Of course, there is always the Circuit Breaker Club. Circuit Breaker Club members pulled the warning horn breakers out on training flights and then forgot to put them back in.

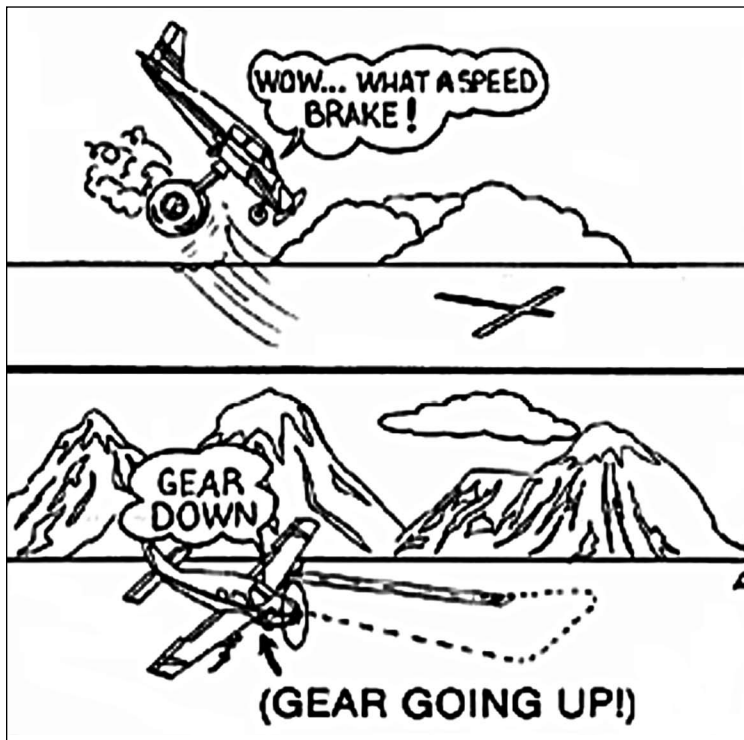

Other pilots cleverly used the landing gear as speed brakes during descent and then manipulated the handle again in the pattern—only to raise the gear by mistake.

The only way to prevent these and other landing gear mishaps is to establish a set routine and stick to it.

*Always put the gear down at a standardized point in the pattern.*

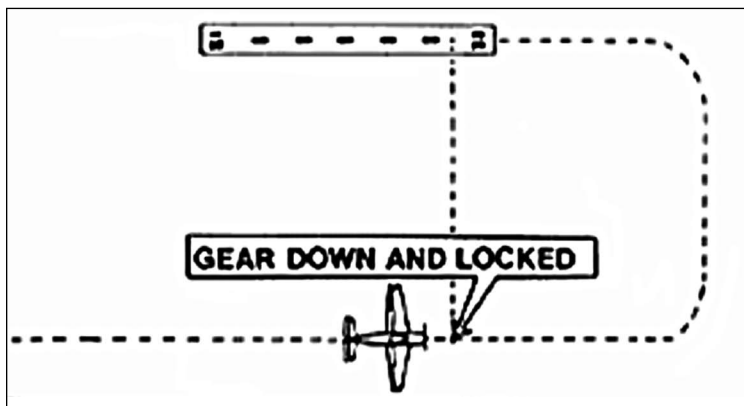

For example, have the gear down and checked before you're on downwind, or, in any event, by the time you are abeam the numbers.

Always use your before-landing checklist and a gas-undercarriage-mixture-prop (GUMP) check.

**Gas  
Undercarriage  
Mixture  
Prop (OR PUMP)**

When lowering the gear, always check the gear indicator for down and locked position. Make it a habit to physically touch the gear indicators and say out loud “gear down,” or “down and locked,” or “three in the green.”

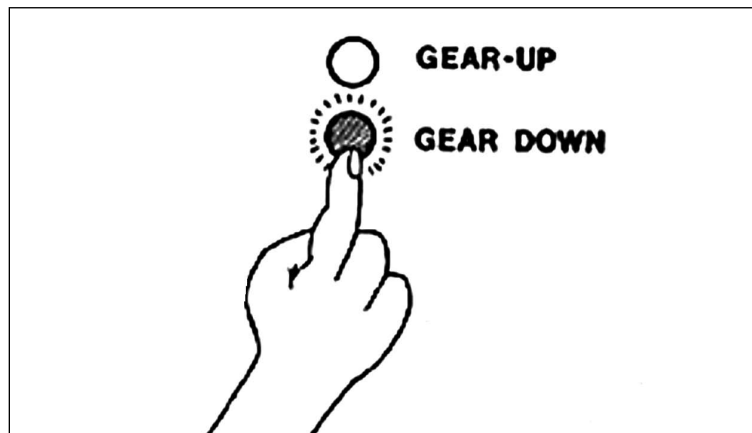

**How To Handle the Gear While IFR**

On an ILS approach, a suggested procedure is to extend the gear at glide slope intercept.

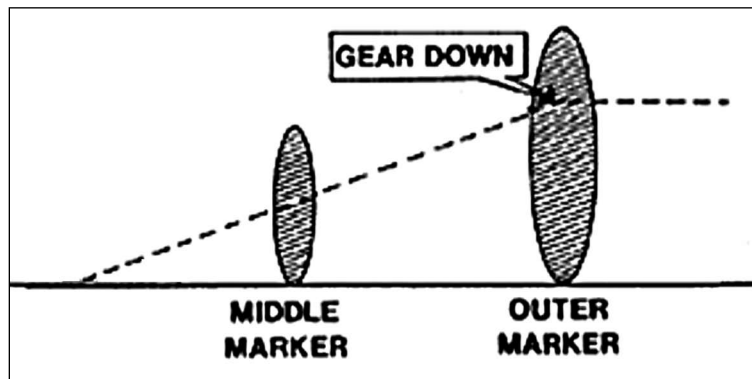

For localizer and VOR approaches, the gear should be extended when passing the final approach fix (FAF) inbound.

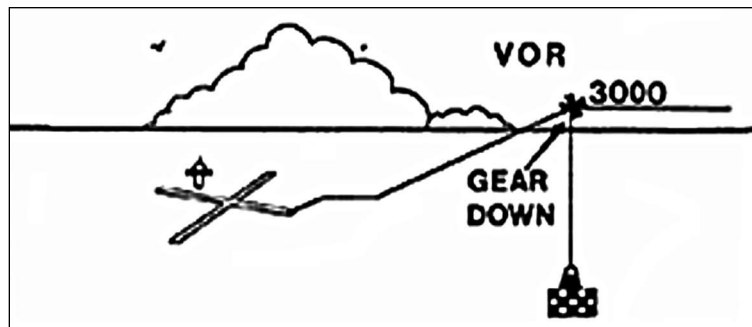

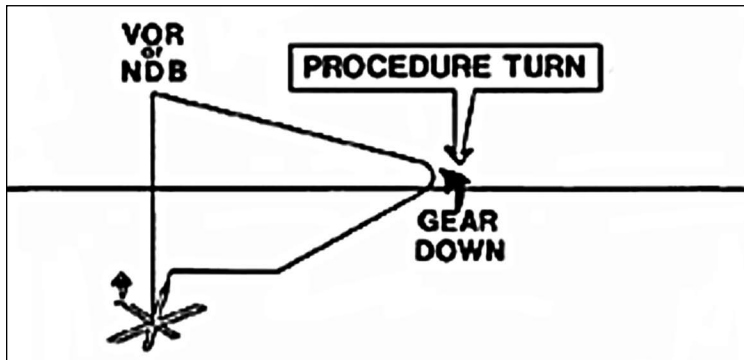

With no FAF, extend the gear when you roll out of the procedure turn and start your final descent.

What about circling approaches? Here there are two schools of thought:

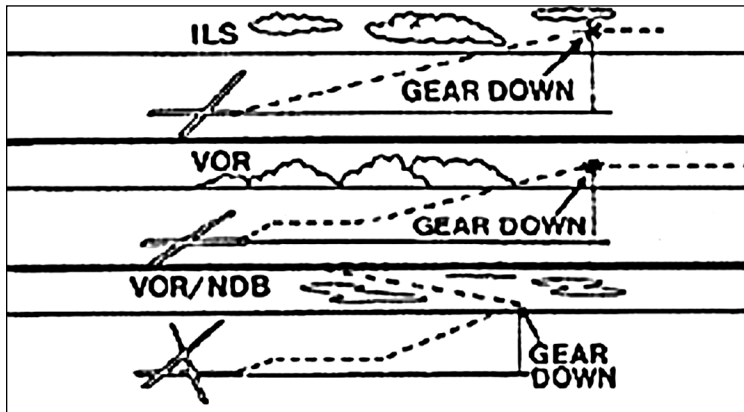

One says to put the gear down as you would while flying a normal IFR approach.

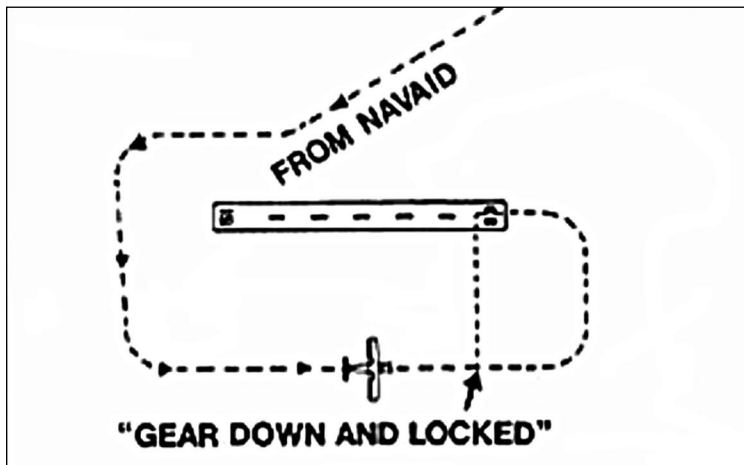

The second method suggests extending the gear on downwind, abeam the runway, if the runway is in sight. The advantage of this second technique is that if you lose the runway, a go-around is easier without the gear already being down. The disadvantage is that it is a deviation from the straight-in habit pattern and may thus cause a distraction when you are trying to keep the runway in sight. Because you may forget the gear, a last gear check on short final is strongly advisable.

The key point is to establish your own gear procedures—and stick to them.

Use your checklist on every landing. Put the gear down at a standardized point every time, and always recheck for three green on short final.

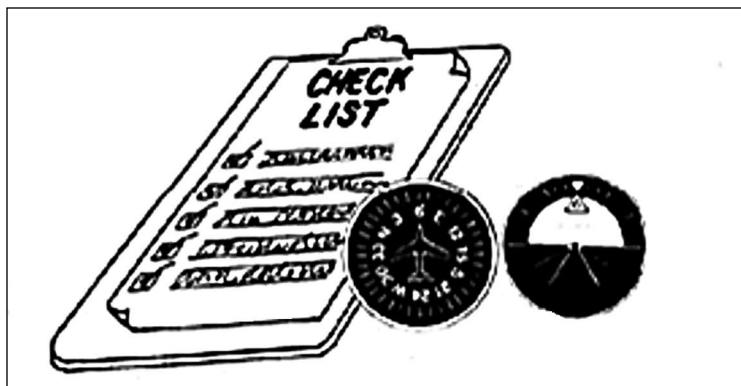

## What About Landing Gear Emergencies?

Always have your checklist and Pilot's Operating Handbook (POH) handy for ready access to emergency procedures.

Other tips? One so basic as to be seldom mentioned is an adequate fuel reserve. Do not stretch the fuel reserve, even in good weather. An unforeseen gear problem at the end of a long cross-country, with little fuel left, is stressful. Leave a cushion of time to work any last-minute problem with the landing gear.

If you have a gear problem, climb out of the pattern and then review your emergency gear extension checklist before doing anything. If necessary, also refer to the POH for a description of the landing gear system. If in doubt, do not hesitate to ask for assistance by radio from an FBO with expertise in your aircraft.

As a general principle, here is the drill for emergency gear extension: Slow the aircraft and then place the gear handle or switch in the "down" position. This is the first step in just about every procedure. Some pilots flying aircraft equipped with only a "one shot" emergency gear extension system have wasted their one and only chance for a gear extension because they forgot the first simple step of putting the gear handle down.

If all else fails, you may have to resort to special flying techniques. One technique is to slow fly the airplane or pull an extra "G" or two by a sharp pull-up to help gravity pull the gear down. Whatever you do, do not outfly your ability or exceed the limits of the airplane.

If you think you will be flying in freezing conditions or will take off from a snow- or slush-covered runway, cycle the gear on departure before you climb into freezing air. Otherwise, the gear may be frozen in the up position when you reach your destination.

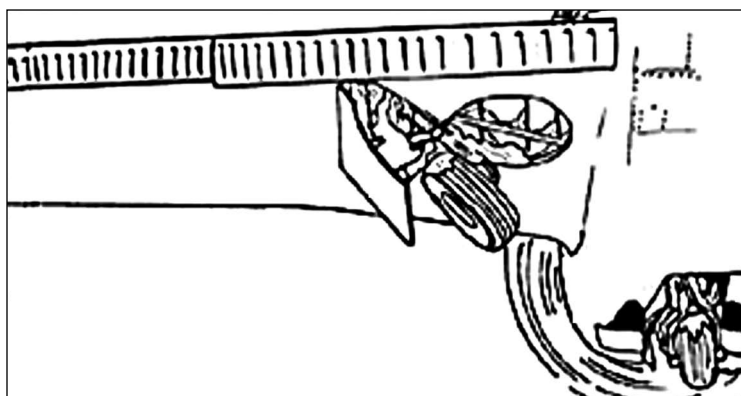

### Another Gear Emergency: The Flat Tire

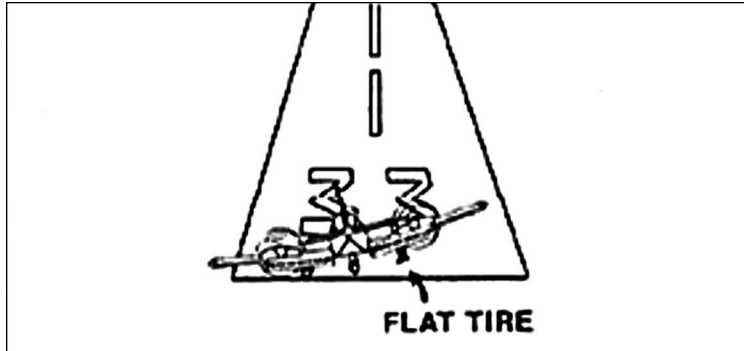

Flat tires do occur occasionally. Some POHs deal with the problem by advising you to burn fuel out of the tank on the same side as the flat. Other procedures call for full flaps, control deflections, and some braking designed to keep the weight on the good tire.

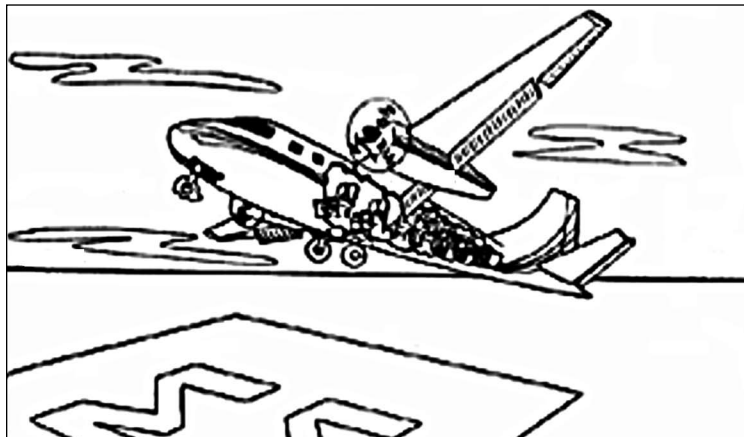

If a nosewheel is flat or the nose gear will not extend, you may want to carefully shift weight aft (within limits, of course) to help hold the nose off the runway until the aircraft slows. Passengers can move to rear seats if these seats are empty.

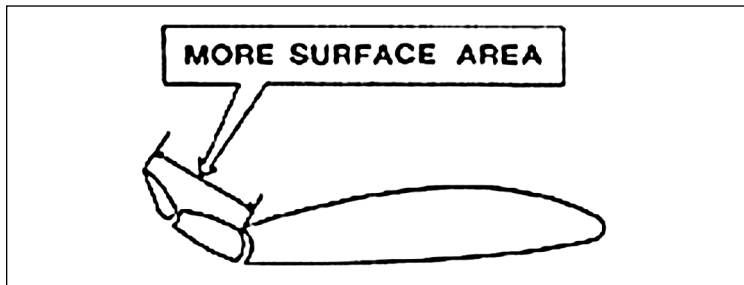

Full down trim can make the “up” elevator more effective on some airplanes.



## Landing on Wet, Icy, or Snow-Covered Runways

Where runway friction is low or nil, aerodynamic braking becomes much more important. Use aerodynamic drag to your advantage on landing—especially when the runway is wet or icy. Simply hold the nosewheel off until it settles on its own.

Braking is not the only problem.

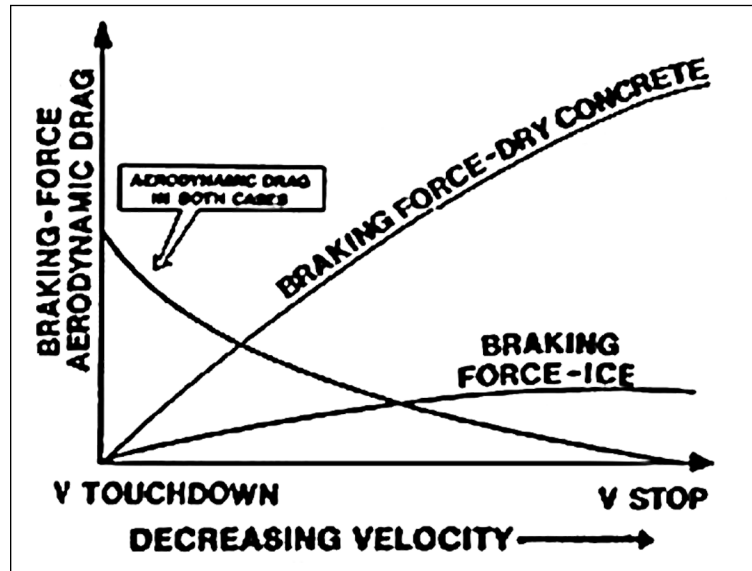

Skidding is another real hazard on a wet or icy runway.

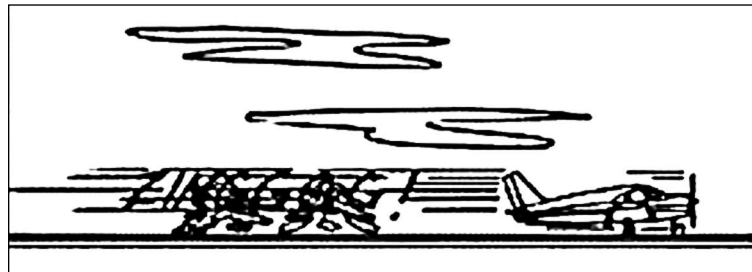

Improper braking is the villain because locked brakes stop the wheels from rolling, and braking effectiveness (not to mention steering effectiveness) drops to nothing.

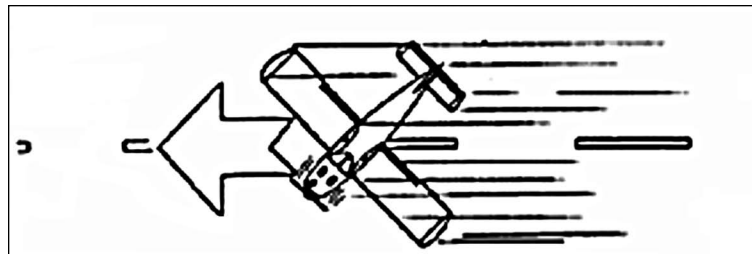

Skidding sideways is a fast ticket to blown tires or collapsed landing gear.

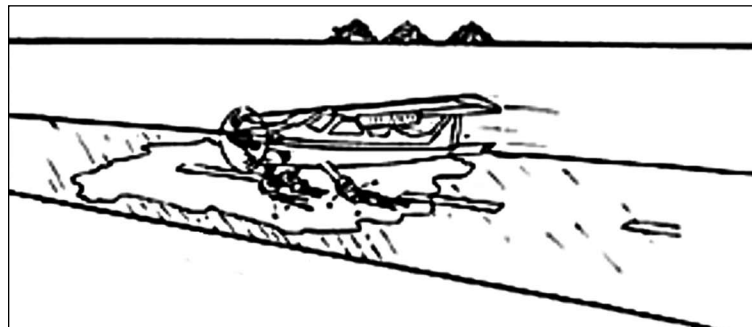

If you have to confront icy or wet conditions, have as many factors going for you as possible.

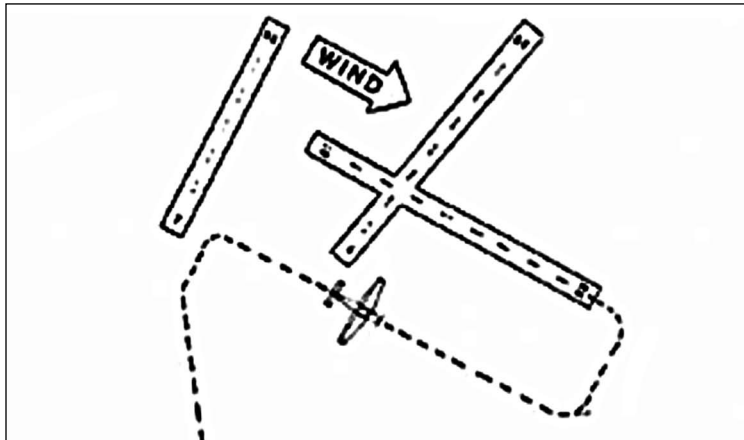

Pick a nice, long runway oriented into the wind. If unavailable, consider diverting elsewhere.



Taxiing on ice is its own headache. If you must taxi, taxi very slowly.

In a twin-engine aircraft, use differential power. Also, use reversible props, if the aircraft is so equipped.



Another point: a clean, plowed runway with snowbanks piled alongside it at the beginning of a sunny day may become a sheet of ice when the melting snow freezes at the end of the day. This situation is something you might not expect in such pleasant, bright weather.



Snow presents other hazards, too.

It is difficult, if not impossible, to judge snow depth on final. Accident reports bear this out in spades. Snow of any depth obscures runway markings.



Continued plowing raises snowbanks on either side of the runway—a definite hazard. The more plowing, the closer they get to the runway.

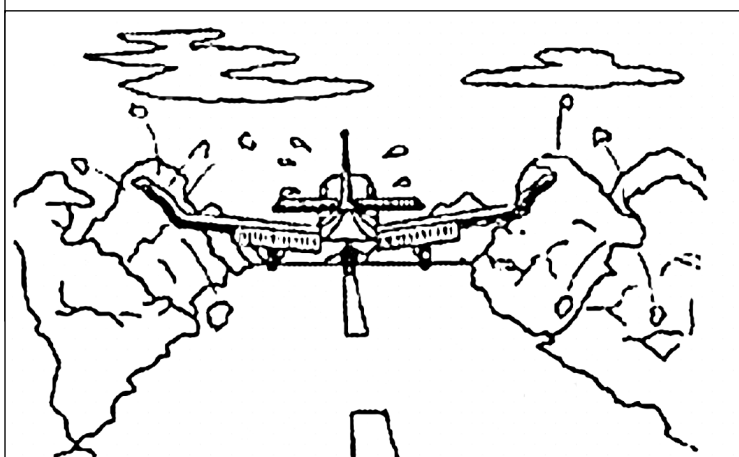

Blowing snow can cause depth perception problems. Sometimes a “white out” results, like landing inside a light bulb. You can miss the runway entirely.

Landing on an icy or snow-covered runway requires advance planning. Check destination runway conditions, such as field condition reports, NOTAMS, and/or call to check with local observers. Never expect conditions to remain constant; they do change rapidly in winter. Get updated weather en route and always have an alternate ready. Finally, check UNICOM for an update before landing.

A word of caution, however, on pilot braking reports: use discretion in interpreting reports of “good” or “poor” braking. These subjective classifications depend on aircraft type and pilot experience plus wind and weather conditions at the time of the report. In some instances, pilots or FBOs are unwilling to give runway braking reports.

Again, when flying in winter, caution is the watchword. Always leave yourself an out, and be sure to carry adequate fuel reserves.

### Water on the Runway and Dynamic Hydroplaning

Spring, summer, winter, or fall —water can accumulate on the runway anytime.

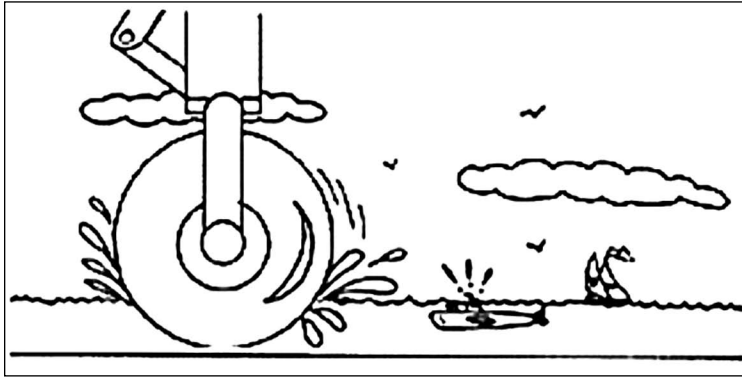

When the runway is wet, you may be confronted with dynamic hydroplaning. Dynamic hydroplaning is a condition in which the airplane rides on a sheet of water rather than on the runway's surface. Because hydroplaning wheels are not touching the runway, braking and directional control are almost nil.



You are literally “surfing.”

### Three Types of Hydroplaning

There are three types of hydroplaning:

1. **Dynamic**—the airplane rides on standing water.
2. **Viscous** —a film of moisture covers the painted or rubber-coated portion of the runway.
3. **Reverted or Melted Rubber**—locked tires on a wet runway can cause heat so intense that the aircraft is actually riding on a mixture of steam and melted rubber.

For now, we will concentrate only on dynamic hydroplaning.

To help minimize dynamic hydroplaning, some runways are grooved to help drain off water. Most runways are not grooved, however.

Tire pressure is a factor in dynamic hydroplaning. Use the simple formula below to calculate the *minimum* speed, in knots, at which hydroplaning will begin. In plain language, the minimum hydroplaning speed is determined by multiplying the square root of the main gear tire pressure, in pounds per square inch (PSI), by 9.

<p><b>MINIMUM DYNAMIC HYDROPLANING SPEED (ROUNDED OFF) =</b></p> <hr style="border: 1px solid black;"/> <hr style="border: 1px solid black;"/> <p><b>9 x √ TIRE PRESSURE (IN PSI)</b></p>
---------------------------------------------------------------------------------------------------------------------------------------------------------------------------------------------------

For example, if your main gear tire pressure were at 36 PSI, you would begin hydroplaning at 54 knots.

$$\sqrt{36} = 6$$

$$9 \times 6 = 54 \text{ KNOTS}$$

Landing at higher than recommended touchdown speeds will expose you to a greater potential for hydroplaning. Once hydroplaning starts, it can continue well below the minimum, initial hydroplaning speed.

When the runway is wet, be prepared for hydroplaning and opt for a suitable runway most aligned with the wind. Landing into the wind gives you the best chance for directional control, but do not count on it. If you hydroplane, make no abrupt control movements. Your brakes will be completely useless, so do not use them. Use aerodynamic braking to your fullest advantage.

In summary, think about runway braking problems well before you land.

## Landing at Night

Night landings have a special element of risk, partly because pilots often do not maintain their night flying proficiency. Do not kid yourself—night flying can be as tough as flying on instruments.

Get some dual night flying with an instructor periodically, and prepare for the unexpected. Shoot some landings without panel lights and, where permitted, without landing lights.

At night, traffic patterns must be flown with extra care. Allow plenty of time to do your pre-landing checklist *before* entering the pattern.

In the pattern, maintain the recommended speeds—do not exceed them. Give yourself plenty of time to prepare for the approach and landing.

A long, low final is to be avoided at all costs and especially at night. The presence of unseen obstacles around the airport is a prime reason to always check flight information publications for airport details before you launch. Know where those obstacles are located before, not after, you approach the airport.



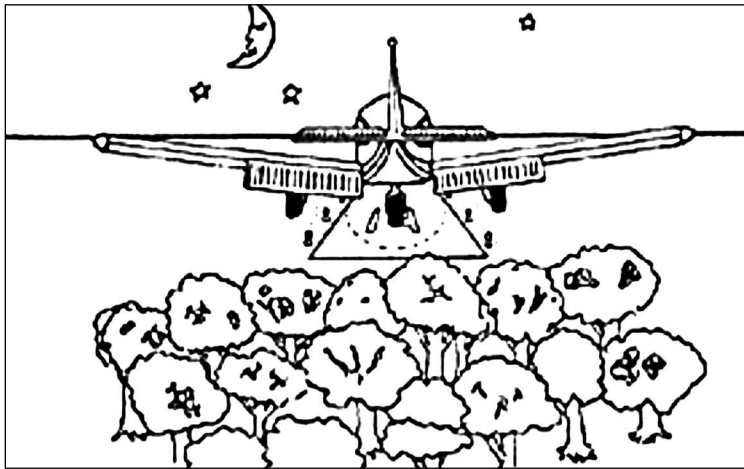

On approach, make sure your glide path is high enough to stay well clear of all obstacles, not just the ones you can see.

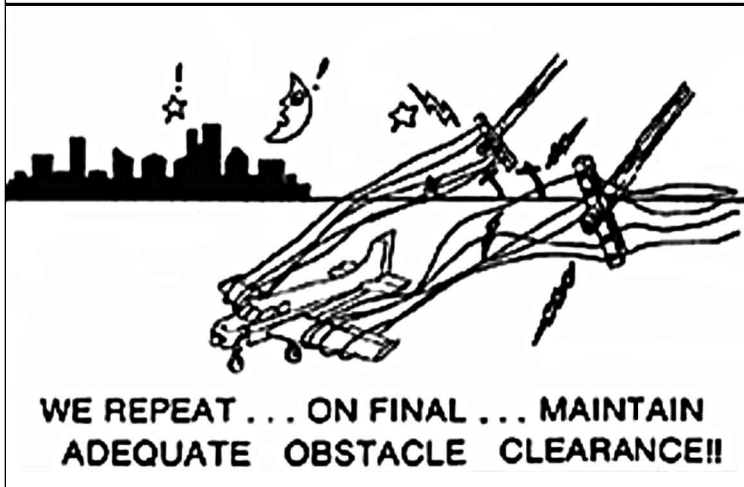
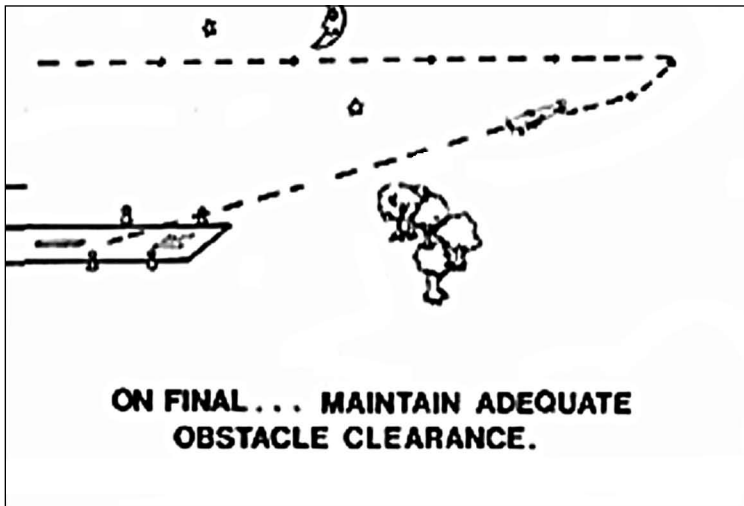



This is also the time to be sure your directional gyro is aligned with the magnetic compass. It will help you locate the runway you will want to use.

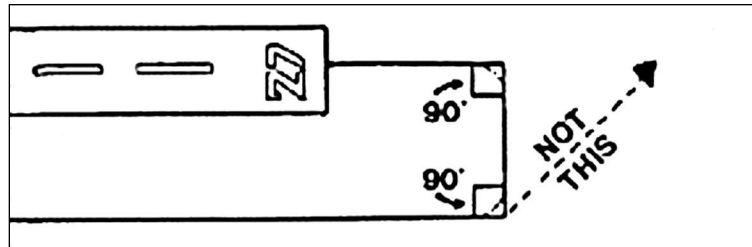

As another aid, set the heading bug on the DG (or heading indicator) if the aircraft is so equipped. The “bug” helps in flying a square pattern at night.

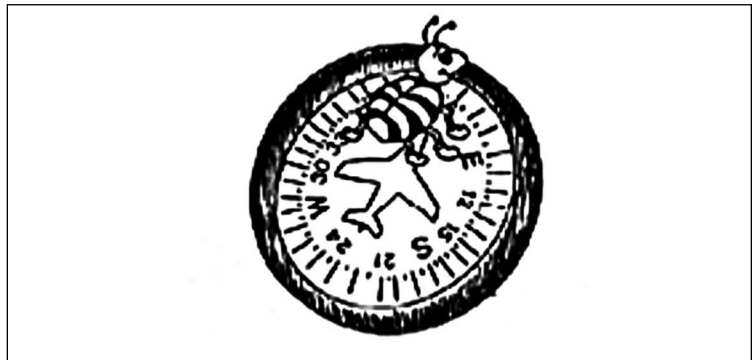

Set your altimeter correctly. Remember, a 1-inch decrease in barometric pressure means your altimeter reading is about 1,000 feet higher than your actual altitude.

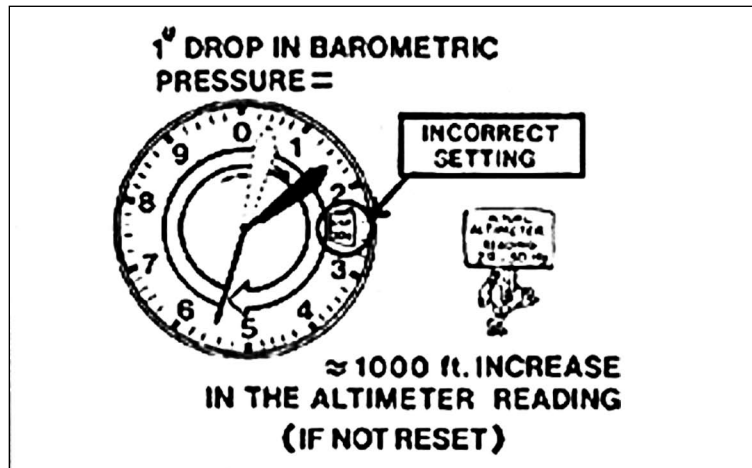

On final, take advantage of VASI guidance where available. Never allow a low indication to appear at night. Get back up to your glide path immediately, or take the aircraft around and try again.

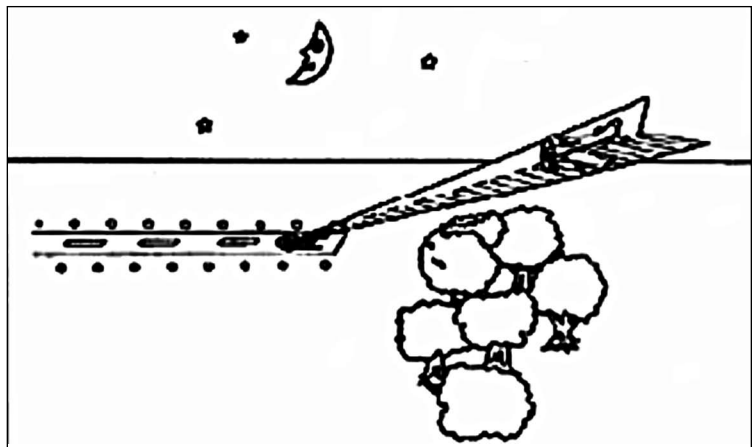

With ATC permission, you can also make use of an ILS to guide you to your landing runway at night.

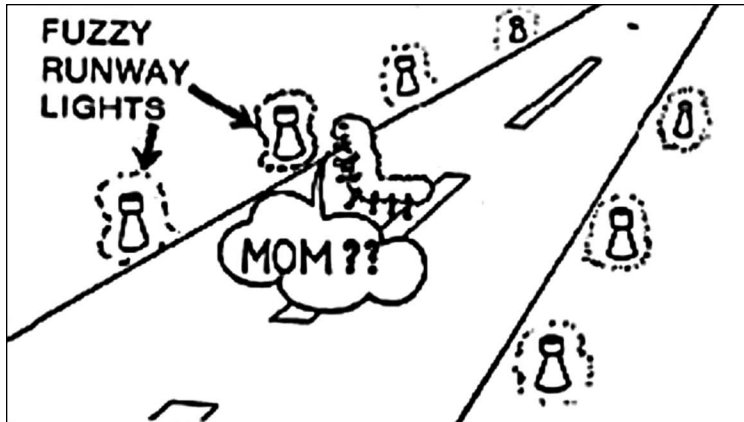

If runway lights become fuzzy on final, beware. You may be seeing the effects of ground fog, which can lead to suddenly reduced visibility as you near the runway for touchdown. Fog can form in minutes, obscuring all or part of any runway. An alternate airport may be your best bet.

Atmospherics can change colors, light intensities, and even depth perception. Even when atmospheric are not a problem, optical illusions can be.

A lighted area may be mistaken for a runway; one airport may be mistaken for another, resulting in landing at the wrong facility. Landings on roads and parking lots are not unheard of when lighting patterns create confusion.

Some airport lighting is radio controlled. Be sure you know how to use this type of lighting; know the specific instructions for the runway lighting installed where you are landing. Flight information publications have the data, including frequencies and procedures to activate these lighting systems, as well as how to raise or lower the light intensity. Many systems turn themselves off after 15 minutes. Do not be caught on short final when the lights go out. If you are caught, go around, turn the lights back on, and try again.



Never attempt a landing at an unlighted airport, no matter how well you think you know it. If in doubt about lighting at your destination, call Flight Service.

At a tower-controlled airport, you may also have the option of asking for the raising or lowering of runway light intensity, if needed.

You can also ask them to “kill the rabbit”; that is, extinguish the sequential strobe approach lights if they become distracting, which they often do when you are close to the runway.



An easy way to enhance your ability to see outside obstacles is to dim the interior cockpit lighting. Know the color coding: aviation red lighting or white strobes mean obstacles to air navigation.

If you are caught dead without a flashlight, it is pilot error. In fact, you should carry a couple of flashlights. They are awfully easy to lose under a seat somewhere, especially when you need one. An old naval aviator's trick is to keep one around your neck on a lanyard.

Flashlights should be in working order. Experienced pilots carry spare bulbs and batteries.

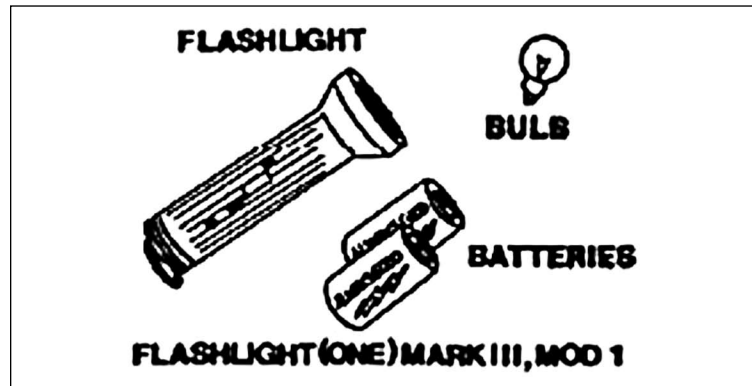

A spare pair of glasses is also important at night. Your eyes work harder at night and it is going to be tough if you lose a contact lens or break your only pair of glasses in flight.



At an airport that is not very busy, it is often best to “drag the field” at 50 to 100 feet on the first pass to check for obstructions and animals at night. Runways hold the day’s heat and animals love to congregate there as the cool night progresses. Also, runways are favorite places for clandestine drag racing.

## The Human Element

When it comes right down to it, most accidents, including landing-phase accidents, are the result of human failure. More specifically, these accidents often result from a failure in the decisionmaking process.



Most accidents end up as attributed to pilot error. That term refers to a whole gamut of problems, including stress overload, being on a mental holiday, or pushing oneself beyond rational limits.

Facts show that some of the worst pilot error accidents happen at night. Perhaps you are so hungry that you can hear your stomach growl, or you are so tired that your eyes burn and your muscles ache. Then there is always the ever-popular “get-home-itis.” Each of these stresses can cause you to rationalize your go/no-go decision and commit a landing accident—the kind of accident that occurs when you are the most tired.

## A Final Word

Landing-phase accidents account for roughly half of all flying accidents each year. It is ironic that they are always the same kinds of accidents. Here are some steps you can take to prevent them:

1. Review the basics—get that knowledge. Sharpen your flying skills. Shoot some landings. Bring your proficiency up to snuff and keep it there.
2. Above all, recognize that you, as pilot-in-command, are the weakest link in the overall man-machine system, especially when you are under stress.
3. Fly relaxed. It will help you make better decisions.

*Note: The suggestions and “rules” given in this document are intended to be helpful aids only and are not intended to replace or supersede the recommendations of the aircraft manufacturer.*

## About This Series

The purpose of this series of Federal Aviation Administration (FAA) safety publications is to provide the aviation community with safety information that is informative, handy, and easy to review. Many of the publications in this series summarize material published in various FAA advisory circulars, handbooks, other publications, and audiovisual products developed by the FAA and used by the FAA Safety Team (FAASafetyTeam) for educational purposes.

Some of the ideas and materials in this series were developed by the aviation industry. The FAASafetyTeam acknowledges the support of the aviation industry and its various trade and membership groups in the production of this series. We would like to acknowledge the contributions of the late William K. Kershner, technical advisor. Also, special thanks to Drew Steketee and Cassandra Bosco, writing and editing; James Gross, illustrations and graphics, layout and design; Gary S. Livack, overall project coordinator; and Ken Johnson, executive producer.

Comments regarding these publications should be e-mailed to [ProductManager@FAASafety.gov](mailto:ProductManager@FAASafety.gov).

Additional copies of this publication may be downloaded or printed at <http://FAASafety.gov>.

